







Enjoy the convenience of automation Sliding Autogate

MAG sliding gate system has been in the market for more than 10 years with proven reliability. It's design has been continuously refined to give you durable performance and yet easily affordable.



- 

Premium matte finish cover with silkscreen logo printing
- 

Plastic base that durable for more than 5 years
- 

Metal gear size = 10mm (Normal market size = 7-8mm) to support up to 800kg gate weight
- 

More speed and more control
- 

Panic alarm feature in emergency situation

SL300 series automatic sliding gate operator

- ✓ Superior built quality with high grade material.
- ✓ Heavy duty limit switch for reliable and consistent positioning
- ✓ Controller firmware based on 10 years site experience to ensure maximum stability.

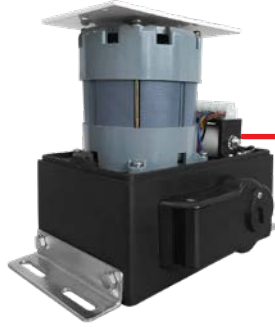

SL300AC

AC240V motor

- Simpler design and lower cost
- Maintenance free
- More powerful to support heavy gate



SL300DC

DC24V motor

- Less heat to support higher open/close duty cycle.
- Higher speed for faster opening / closing.
- Dual speed control for cushioning.
- Support backup battery in the event of power failure.

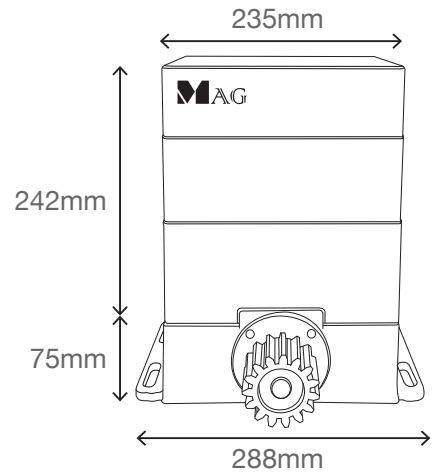

Technical specification

Description	DC	AC
Power	DC24V	AC240V
Motor RPM	2800 max	1400 max
Gate Weight	Nylon Gear 600kg, Metal Gear 800kg	Nylon Gear 600kg, Metal Gear 800kg
Temperature operating	120°C ± 0.5	120°C ± 0.5
Lubricate	Grease type	Grease type
Power consumption	80 watt	370 watt
Travel Speed	12 meter/min	12 meter/min
Remote Control	Effective range 30m, max 50m	Effective range 30m, max 50m
Manual Option	Special release key during power failure	Special release key during power failure
IP Rating	IP55	IP55

Installation diagram

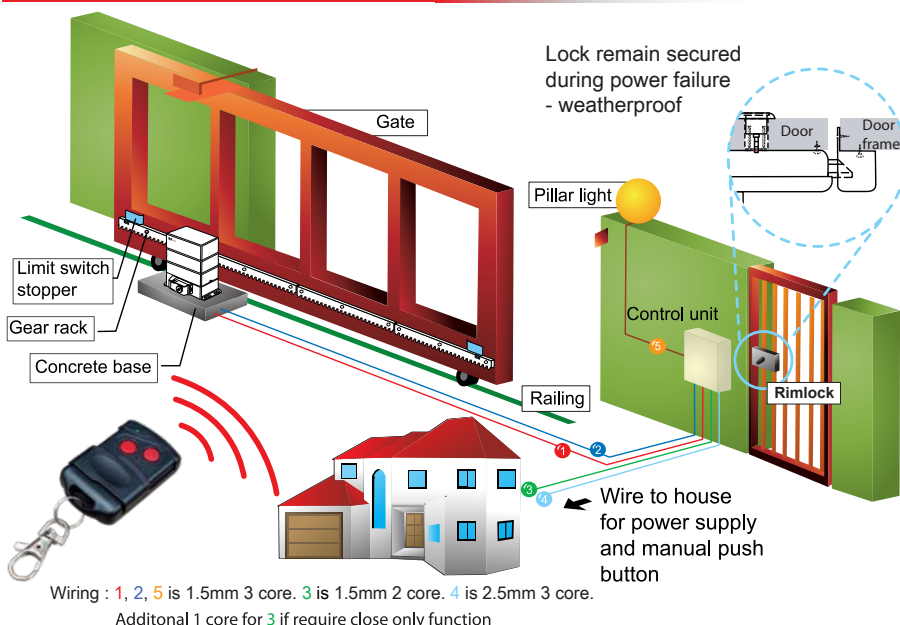

Authorised Dealer:

Copyright © 2016 Magnet Security & Automation Sdn Bhd. All rights reserved.

All specification, drawing and product info are subject to change without prior notice.